











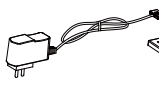











Art.-Nr.: 708.07
 PYT 07/16

1x 1x incl. 2x 1x



Art.-Nr.: 708.08
 PYT 07/16

1x 1x 1x incl. 2x 1x

F

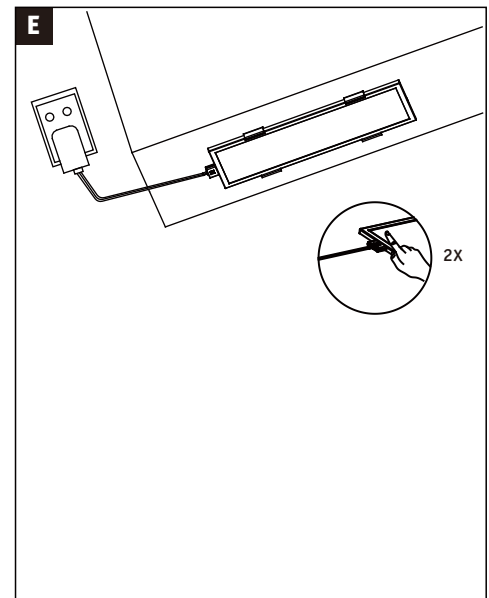
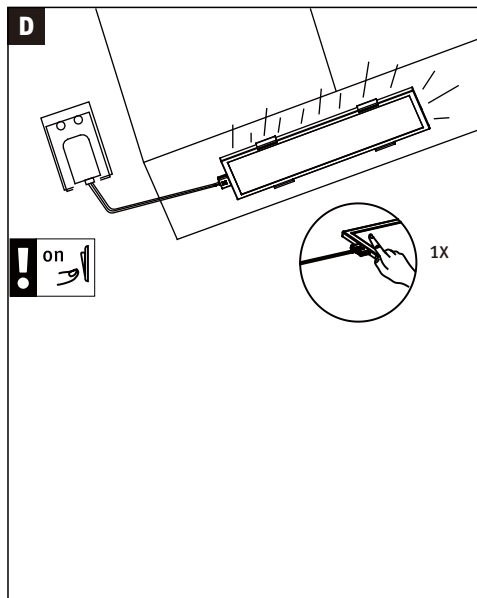
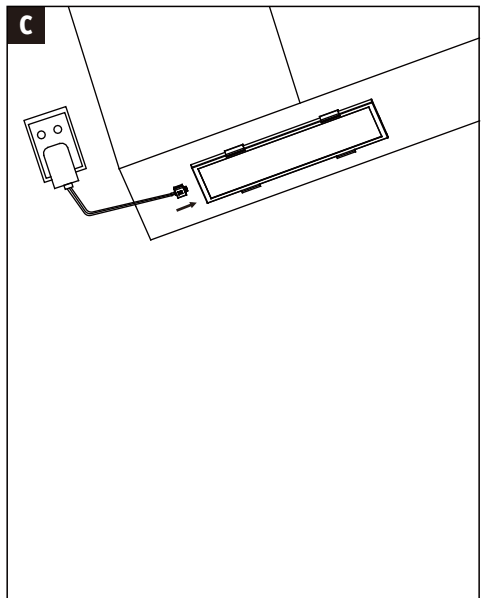
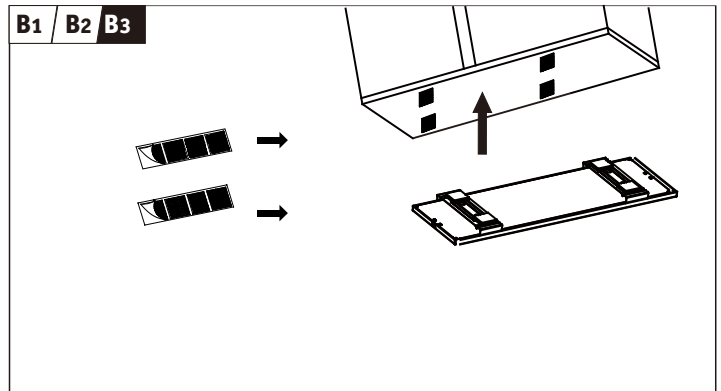
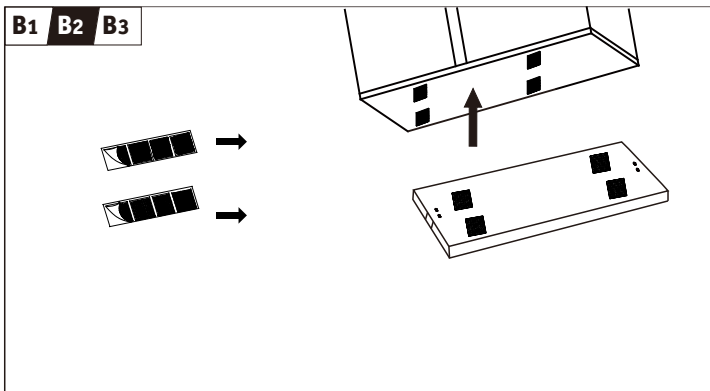
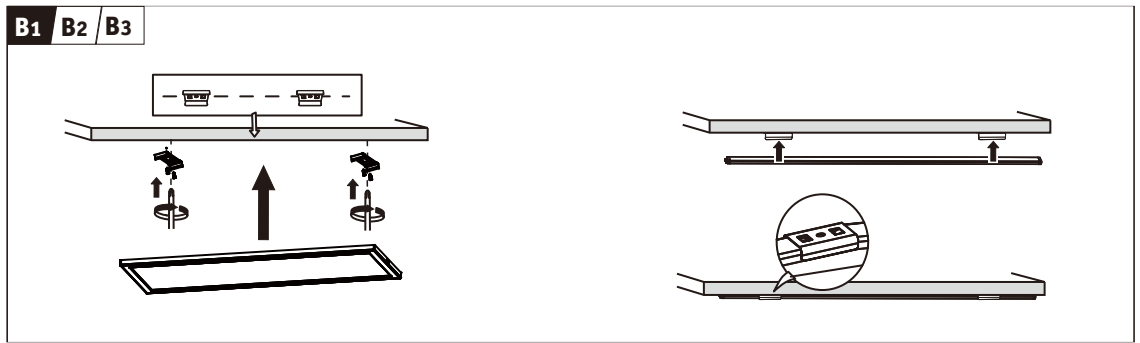
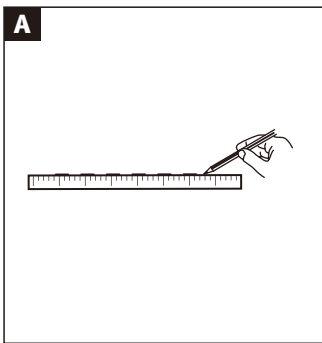

G1 G2

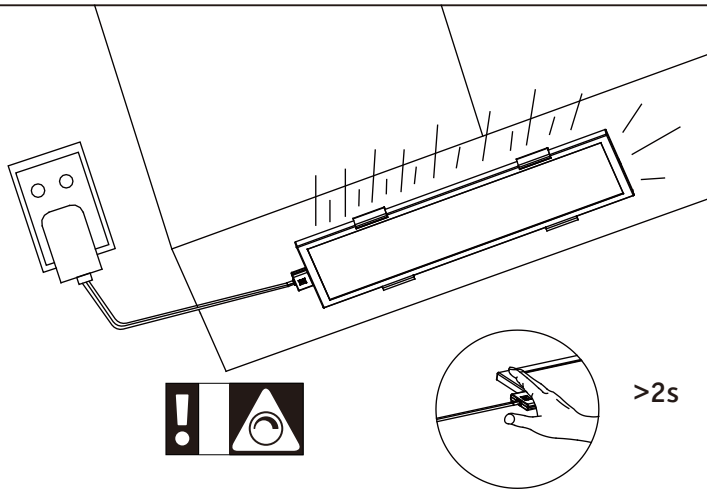

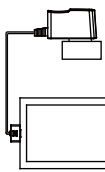
1.

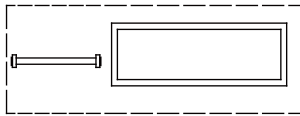

2.

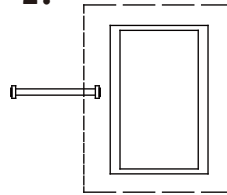

 Paulmann
Art.-Nr:708.08

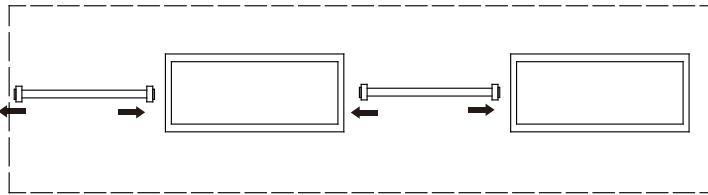
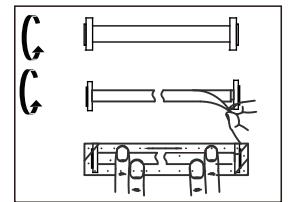

+...Max.2*

G1 G2

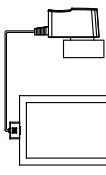

1.

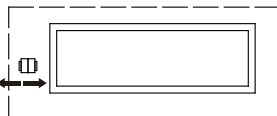

2.

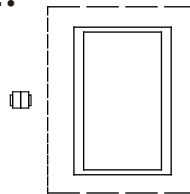

 Paulmann
Art.-Nr:708.08

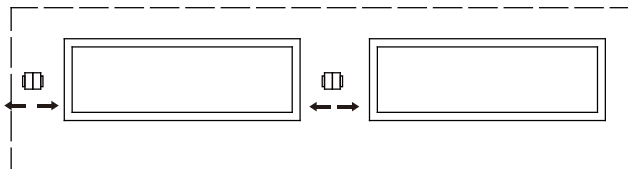
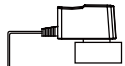

+...Max.2*